

GIRO

Fabio Bortolani | 2011



GIRO

Fabio Bortolani | 2011

GIRO recalls the American movie house and coffee houses but it has the look of Italian lightness. Made of a metal band, its shape is a gently concave circle that accommodates the seat. The flexibility is in its screw, which adjusts its height and delights its movements.



GIRO

Fabio Bortolani | 2011

| S106 Swivel stool height-adjustable H66 ÷ 76

Stool with swivel seat and adjustable height with screw. Base in sandblasted stainless steel Aisi304 or powder coated. Foot-rest in stainless steel. Seat in curved plywood in several finishes. Glides in polythene.

TEST EN 1728:2012 AC:2013 6.17 - EN 16139:2013 - L2 extreme

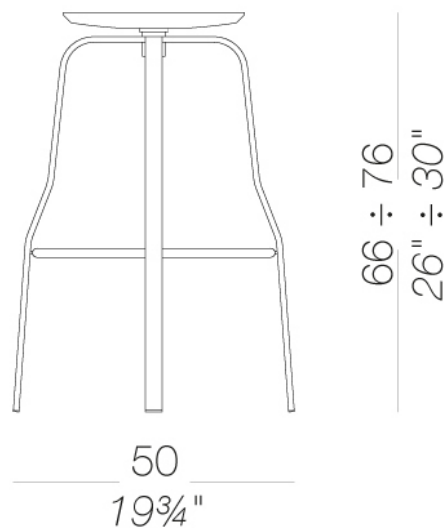

GIRO

Fabio Bortolani | 2011

| S106S Swivel stool height adjustable H66 ÷ 76

Stool with swivel seat and adjustable height with screw. Base in powder coated steel and foot-rest in stainless steel. Seat and backrest in curved plywood in several finishes. Glides in polythene.

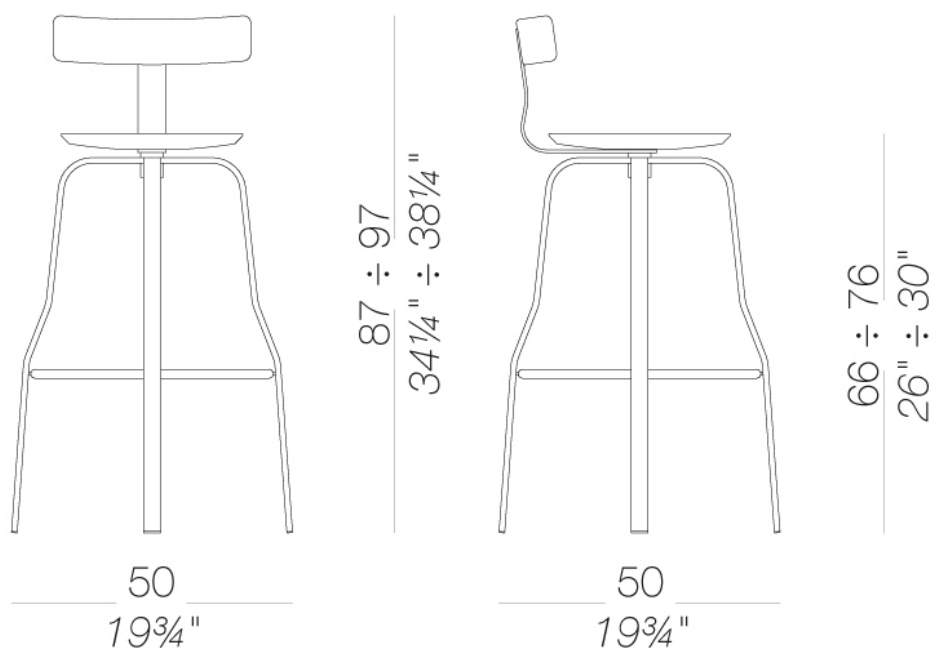

GIRO

Fabio Bortolani | 2011

frame



powder coating
black
1 Colors

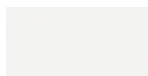

powder coating
white
1 Colors



metal
stainless steel
1 Colors

seat/back



wood
blanched oak
1 Colors

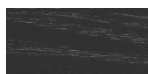

wood
black open pore
1 Colors

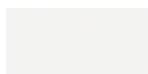

lacquered
white lacquered
1 Colors

seat



wood
blanched oak
1 Colors

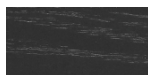

wood
black open pore
1 Colors

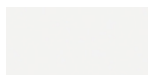

lacquered
white lacquered
1 Colors



metal
stainless steel
1 Colors

upholstery

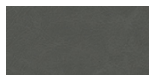

soft-leather
soft-leather
7 Colors

consult the portfolio for the range of colors, fabrics, eco-leather, soft-leather.

use and maintenance instructions

Clean all parts in wood, leather, fabric and metal with a damp cloth or a diluted neutral cleaner. Do not use cleaners with alcohol, bleach, solvent or abrasive products. Any liquid spilt on the product must be wiped up immediately. When lifting or moving the product, hold it on the structure and not under the seat. The product should not be subjected to unbalanced weights, as it is designed for a proper rest on the foothold (on four legs or on the base). Our company relieves from any responsibility in case of damage caused to fragile floors. Avoid any improper use of the product: do not step on the product, on the footrest or on the armrests. Avoid any movements that could compromise the proper functionality of the product or the safety of the users. Wood and leather, being natural materials, could be easily damaged. Small impurities or imperfections are within quality standard range. Do not expose the product to weather conditions or atmospheric agents, nor to heat sources over 40°C. Also products for outdoor use could be afflicted by atmospheric agents. The product could undergo possible exterior changes due to particular exposure to heat, humidity and saltiness. An appropriate and frequent maintenance and cleaning of the product enhances its durability. The product could change colour and shade, if exposed to direct sunlight. Maintenance has to be carried out by experienced staff. Dispose of the package only after assembling the product, in order to avoid the loss of ironmongery and components. Once the product has been dismantled, the product itself or its components must be given to the public garbage disposal system, according to the legislation in force.